

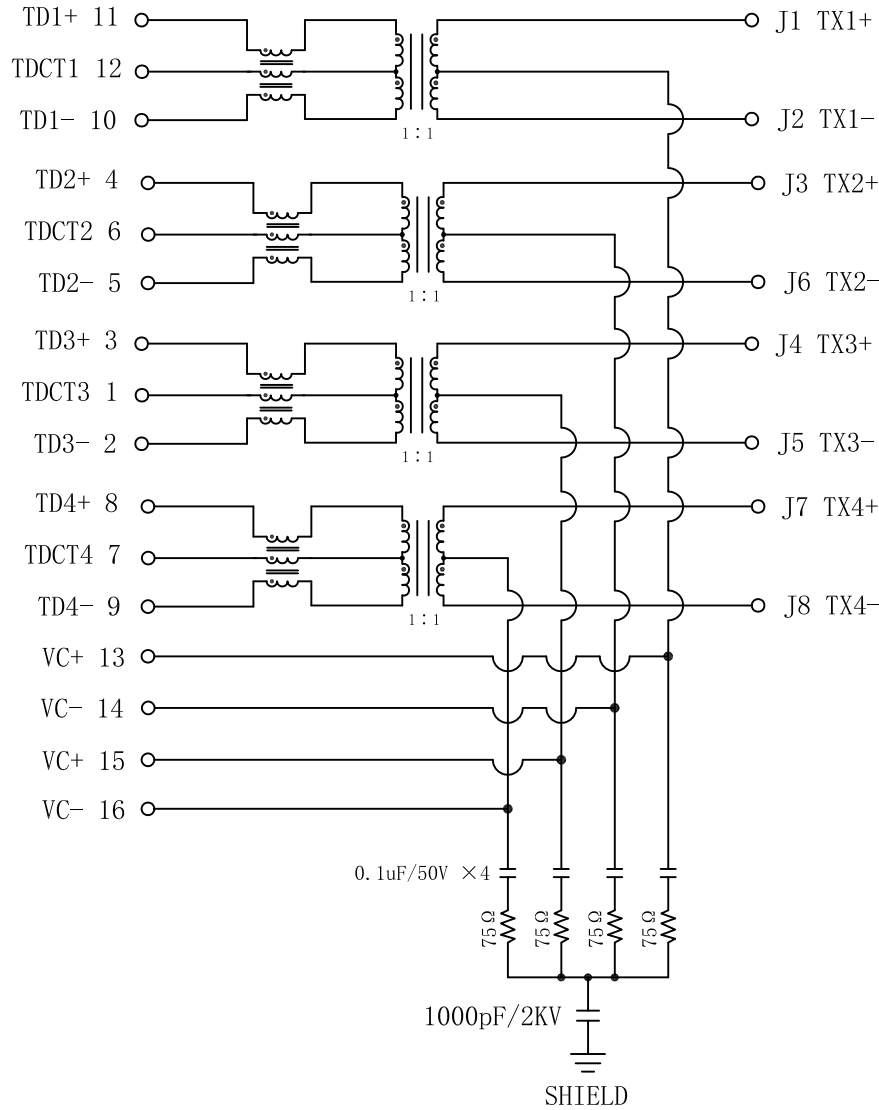

# Schematic:

REV.	ECN NO.	DESCRIPTION	DATE	APPD
A	REL		2015-7-11	

PC BOARD CONNECTIONS



RJ45 CONNECTOR

### Electrical Specifications @25°C

- Inductance: 350uH Min @ 100KHz, 0.1V, 8mA DC BIAS
- Turns Ratio( $\pm 3\%$ ): Pri:Sec = 1CT:1CT
- Insertion Loss: 1-100MHz:-1.1dB Max
- Return Loss: 1-40MHz:-18dB Min  
60MHz:-14dB Min  
80MHz:-12dB Min  
100MHz:-10dB Min
- Crosstalk: 1-100MHz:-35dB Typ
- Common Mode Rejection: 0.1-30MHz:-38dB Typ  
30-60MHz:-35dB Typ  
60-100MHz:-30dB Typ
- Designed for PoE applications with maximum current of 350mA per pair
- Hipot: 1500Vrms Min
- Operating Temperature: 0°C ~ 70°C.

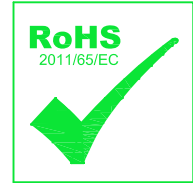

X:X	$\pm 0.25$	APPD:	<b>Trxcom</b> Huizhou Trxcom Electronics Co.,Ltd.	
X:XX	$\pm 0.20$	CHKD:		
X:XXX	$\pm 0.05$	DR: SEA	TITLE: RJ45 Connector with 1000 Base-T Integrated Magnetics For PoE Application	
ANGLES	$\pm 1^\circ$	UNIT: mm	PART NO.: TRJK2072CNL	
	SCALE: 2/1	SHEET: 2/4	REV: A	DWG NO.: TRC15071129

# Profile of wave solder:

REV.	ECN NO.	DESCRIPTION	DATE	APPD
A	REL		2015-7-11	

## SUGGESTED PROFILE OF WAVE SOLDER FOR ROHS PRODUCT

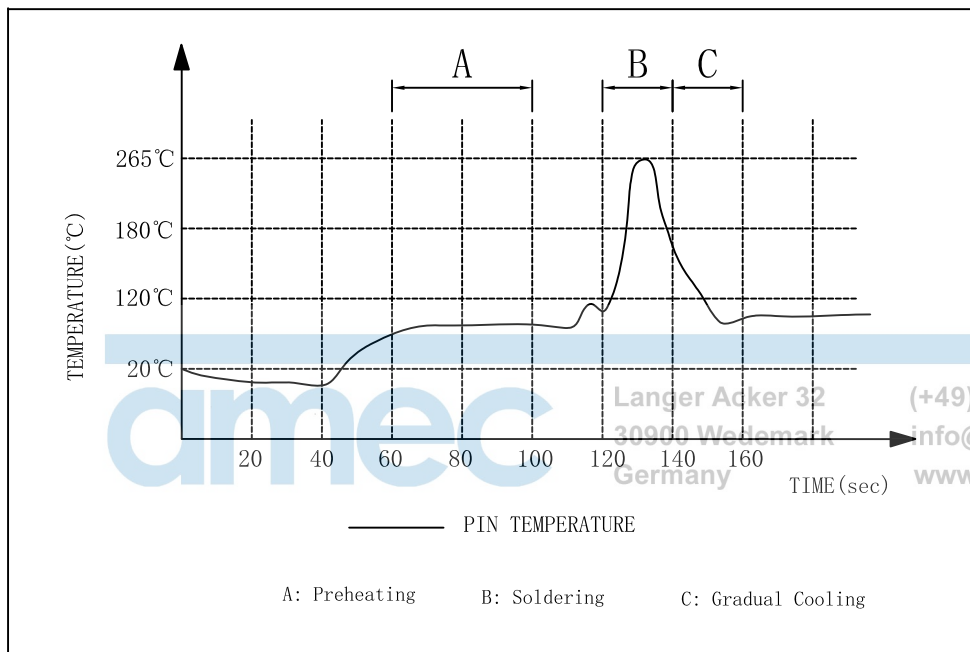

- (1) Tip Temperature: 265°C max
  - (2) Tip Temperature time: 5sec max
- Note: The melting point of Tin: 219°C

X:X ±0.25	APPD:	<b>Trxcom</b>
X:XX ±0.20	CHKD:	
X:XXX ±0.05	DR: SEA	TITLE: RJ45 Connector with 1000 Base-T Integrated Magnetics For PoE Application
ANGLES ±1°	UNIT: mm	PART NO.: TRJK2072CNL
	SCALE: 2/1	SHEET: 3/4
	REV: A	DWG NO.: TRC15071129

Packaging:

REV.	ECN NO.	DESCRIPTION	DATE	APPD
A	REL		2015-7-11	

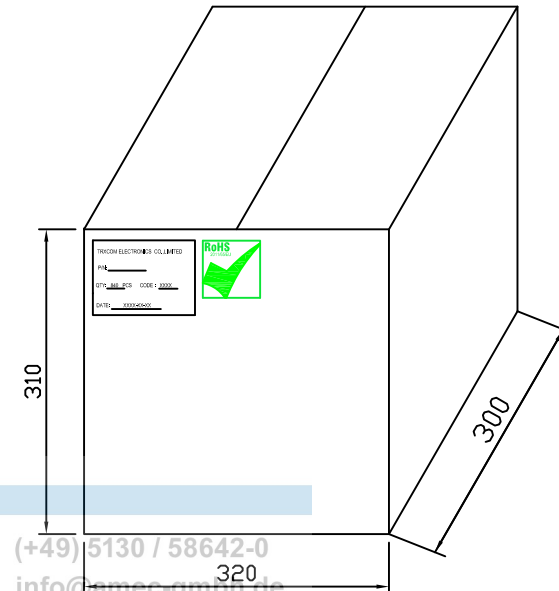
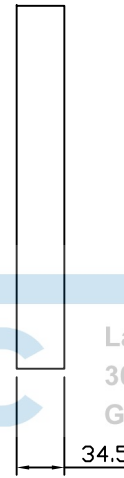
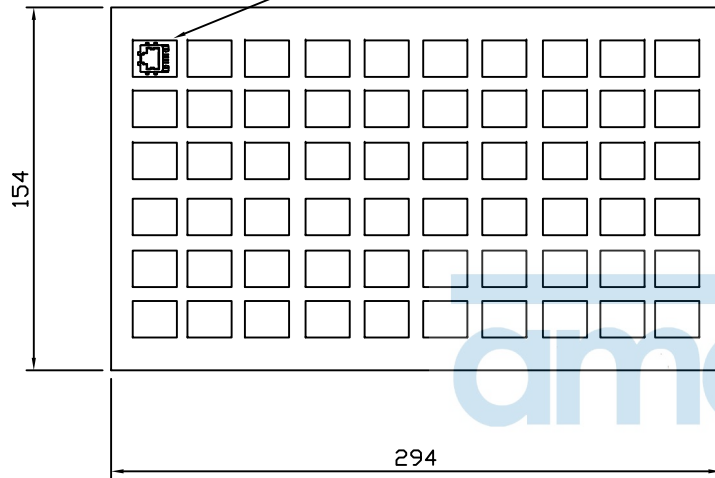
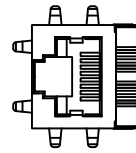

Langer Acker 32  
30900 Wedemark  
Germany

(+49) 5130 / 58642-0  
info@amec-gmbh.de  
www.amec-gmbh.de

- ◆ Packaging unit :60pcs/tray
- ◆ Packaging material:PVC
- ◆ Outer carton unit:840pcs/14tray/box
- ◆ Net Weight:7kg
- ◆ Gross Weight:9kg

X:X	±0.25	APPD:	<b>Trxcom</b> Huizhou Trxcom Electronics Co.,Ltd.	
X:XX	±0.20	CHKD:		
X:XXX	±0.05	DR: SEA	TITLE: RJ45 Connector with 1000 Base-T Integrated Magnetics For PoE Application	
ANGLES	±1°	UNIT: mm	PART NO. : TRJK2072CNL	
	SCALE: 2/1	SHEET: 4/4	REV: A	DWG NO. : TRC15071129